

Divani . Sofas

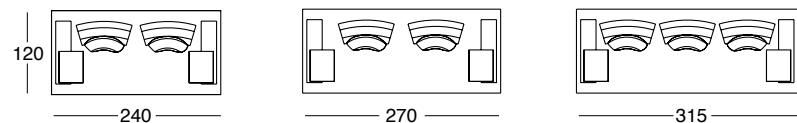

Relax sx-dx . lh-rh chaise longues

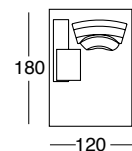

Pouff . Pouffe

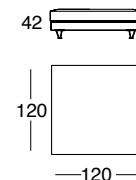

Rullo . Bolster cushion

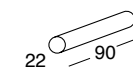

Cuscino bracciolo . Armrest cushion



Terminali arco . Curved end units

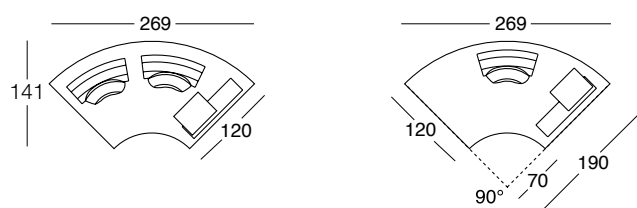

Mezzo tondo . Semicircular Tondo . Circular

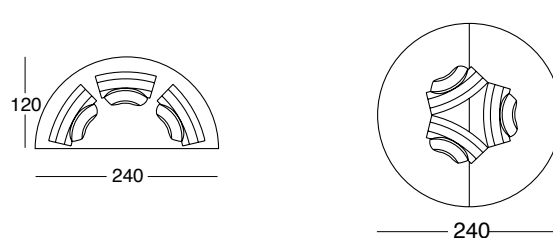

Trapezio . Trapezoid

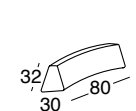

Cuscino schienale . Backrest cushion

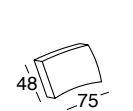

Bracciolo . Armrest

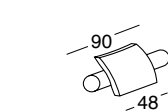

Schienale . Backrest

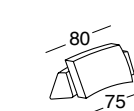

Basi . Base units

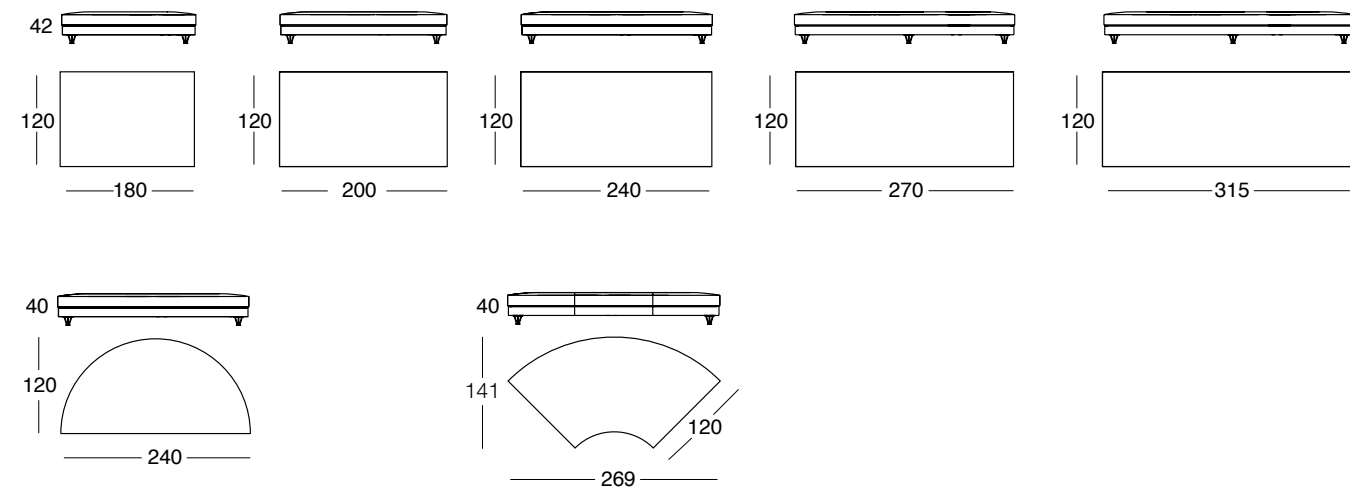

Struttura interna in acciaio verniciato, garantita 10 anni. Imbottitura in poliuretano espanso a quote differenziate. Sotto rivestimento in fibra acrilica accoppiata. Bracciolo cilindrico, costruito in poliuretano espanso, coperto da soffice falda di piuma. Schienale in poliuretano espanso ricoperto con falda di poliestere. Schienale e bracciolo contengono al proprio interno una serie di sfere nichelate, che consentono agli stessi di rimanere stabili e fissi, in qualsiasi posizione vengano collocati. Cuscini volanti in piuma d'oca canalizzata. Tutti gli elementi sono completamente svestibili.

Painted steel internal structure, guaranteed for 10 years. Multidensity polyurethane foam padding, upholstered with bonded acrylic fibre. The cylindrical armrest is made of polyurethane foam, covered by a soft layer of feathers. The polyurethane foam backrest is covered with a polyester layer. The backrest and armrest have a series of nickel-plated spheres inside to remain stable in any position. Removable cushions in goose down in baffle channels. The covers can be removed from all pieces.